

**ELECTRIC POWER SYSTEMS
ENGINEERING COMPANY (EPS)**



020~~~2

ANNUAL REPORT

Established 1982

2021



Table of Contents

Company Profile	5
Message from the CEO	5
Company Data	7
Introduction	8
Mission	9
Vision	9
Objectives	10
Organization	11
Projects Group	11
Consultants	11
Facilities	11
Organization Structure	12
Key Personnel	13
Ownership	14
Major Organizations Recognizing EPS	15
Contracts Share till end of 2021	15
Activities and Services	16
Company Sectors	
Distribution Networks	19
Scope of work	20
Projects served	20
Major Projects	21
Substations	23
Scope of work	24
Projects served	24
Major Projects	25
Overhead Transmission Line (OHTL) & Under Ground Cables (UG)	32
Scope of work	33
Projects served	33
Major Projects	35
Civil Works	39
Scope of work	40
Projects served	40
Power Stations Projects	45
Scope of work	46
Total generation capacity served	46
Major Projects	50

Table of Contents

Overseas Operations	53
Scope of work	54
Overseas Projects	54
Major Projects	55
Networks Studies and Control System	59
Scope of work	60
Projects served	64
Information Technology	65
The Role	66
The activities	69
Projects served	70
EPS Training Center	73
Services	74
EPS Stuff Training	76
External Trainees	76

MESSAGE FROM THE CEO



Electric Power System Engineering Company (EPS) is specialized in carrying out consulting and engineering services in the field of Electric Power Systems. EPS, a joint-stock Egyptian Company, established in October 1982 according to the laws of the General Authority for Investment and Free Zones.

Since its establishment, **EPS** is offering services in the fields of Electric Power Generation, Transmission Line, Distribution Systems, control & communication, Transformer Substations, Power System Planning and Information Technology and is ISO 9001 /2015 certified since February 1.2001 Until June 2023.

The services covered include power system planning, techno-economic feasibility studies, power system design, and preparation of tender documents, bid evaluation, contracting support, and project management.

EPS has developed extensive packages of software applications oriented to automate managerial and financial processes, as well as, to support management decision-making.

Furthermore, **EPS** participated in international consultancy and contracting services for various Arab & African countries. During the last 30 years, **EPS** has succeeded to increase its scope of services extensively, and successfully, undertaken to cover a wide range of activities for more than **5380** projects. The company has also been engaged in several consulting and engineering services for generation, transmission, and distribution projects in Arab and African Countries. **EPS** is a recognized leader in power systems analysis and network expansion planning, sub-stations, transmission lines, distribution networks, and SCADA projects. One of the main focuses of the Company is to deliver quality and cost-effective services that satisfy the customers. To achieve customer satisfaction.

EPS is committed to provide quality and cost-effective engineering services in the field of electric power systems that fully meet the needs and expectations of every customer through expertise and standard of excellence. The company is also dedicated to use information technology to develop systems driven by customer need.

EPS vision is to be successful, well reputed, continues to serve a growing.





EPS also envisages expanding the services into business architecture and strategic Planning. Information technology is linked to business architectural and surveying issues to form an integral part of the business delivered to public sector, private sector and inter professional activities covering National and Regional markets.

Eng. Elhussieny ElFar
EPS Chairman & CEO



COMPANY DATA

Chairman & CEO	: Eng. Elhussieny ElFar
Capital	: 5 Million LE
No. of Employees	: 281
Year of Establishment	: 1982
Address	: Misr Lel-Taamir Buildings - Sheraton Heliopolis, Zone 8, Street No. 9, Building No. 7
P.O. Box	: 90 Rawdat El Sheraton
Tel.	:(202) 22669414 – 22669424 – 22669427 – 22669437
Fax	:(202) 22661810
E-mail	: eps@eps-egypt.com
Web Site	: www.eps-egypt.com
Nearby	: Cairo Airport, Radisson Hotel , Fairmont Hotel

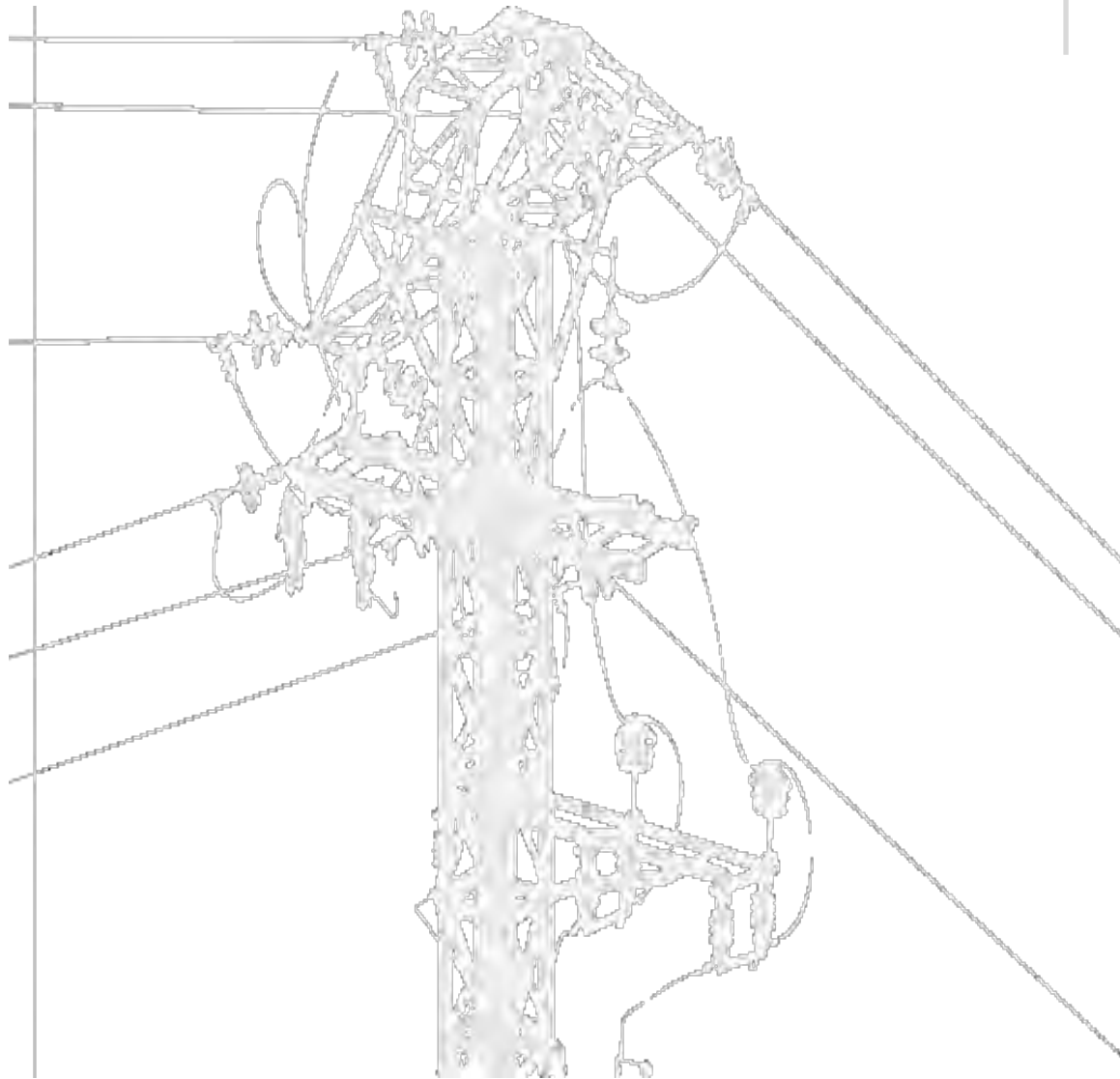



INTRODUCTION

EPS is a joint stock Egyptian Company established in October 1982 under the laws of the General Authority for Investments and Free Zones. The company is specialized in carrying out engineering and construction management services in the field of Electric Power Systems.

Since its establishment, *EPS* has conducted services for more than **5380** engineering projects in the fields of electric power generation, transmission and distribution in Egypt and in Arab Countries.

The services cover power systems planning, techno-economic feasibility studies, power systems analysis, preparation of tender documents and contracting support, supervision at construction sites, operation & Maintenance, development and implementation of information technology applications. In addition, *EPS* carries out preparation and execution of training programs.

From inception to completion, we prepare tender documents, plan, execute, and control projects backed by proactive planning and first-hand knowledge of contract terms, client objectives, responsibilities, and capabilities. Project budgets are continuously monitored to secure budget and contract compliance.

Engineers, technologists in addition to teams that are comprised of a variety of professions and disciplines are pooled to create effective project organization structures.

MISSION

EPS is committed to provide quality and cost-effective engineering Services in the Field of electric power systems that fully meet the needs and expectations of every customer through expertise and standard of excellence. The Company is also dedicated to use information technology to develop systems driven by Customer needs.

VISION

EPS vision is to be successful, well reputed, and continues to serve a growing market and can, with no limitations, compete local consultants.

EPS also envisages expanding the services into business architecture and strategic planning. information technology is linked to business architectural and Surveying issues to form an integral part of the business delivered to public sector, private sector and inter professional activities covering national and regional markets.

OBJECTIVES

EPS objectives are:

- ⚡ To operate the company for continuity, profile and stability and establish growth objectives through effective management policies and planning procedures.
- ⚡ To provide shareholders with fair return on investment.
- ⚡ Employee performance to be stimulated information systems that serve the processes and the management.
- ⚡ Invest in corporate development and individual training.
- ⚡ Continually provide employees with modern efficient development and production tools to be in the forefront in the fields of the firm's practice.
- ⚡ Opening new markets.
- ⚡ Achieve continuous customer satisfaction.
- ⚡ To maintain relations with employees through active participation, adequate communication, fair compensation and benefits, good working conditions opportunities for work satisfaction, advancement and professional development.

Organization

EPS is organized to offer a full range of consultancy and engineering services in the fields of power systems engineering. Each individual project is managed with only one goal in mind, which is to render the services required at the highest international standards.

Projects Group

For each specific project or task, a number of specialized engineers are integrated to form a project team, managed by a long-experienced team leader or project manager. Those specialists are assigned from the company's different departments to perform their respective tasks in accordance with established schedules and milestones to fulfill the project objectives.

To provide an even wider range of engineering capability, *EPS* draws directly from the highly qualified and experienced personnel working with the different authorities and organizations of the Electricity and Energy sector

Consultants

EPS has expanded its technical resources and engineering groups by employing consultants and specialists of the highest caliber as either inhouse or independent consultants to support the projects and project teams.

Facilities

The Company has computer facilities and software packages which provide considerable support during the implementation of different contracts.

EPS also maintains continuous liaison and special agreements with various specialized laboratories and research centers, in order to avail on their facilities and expertise whenever necessary.

Organization Structure

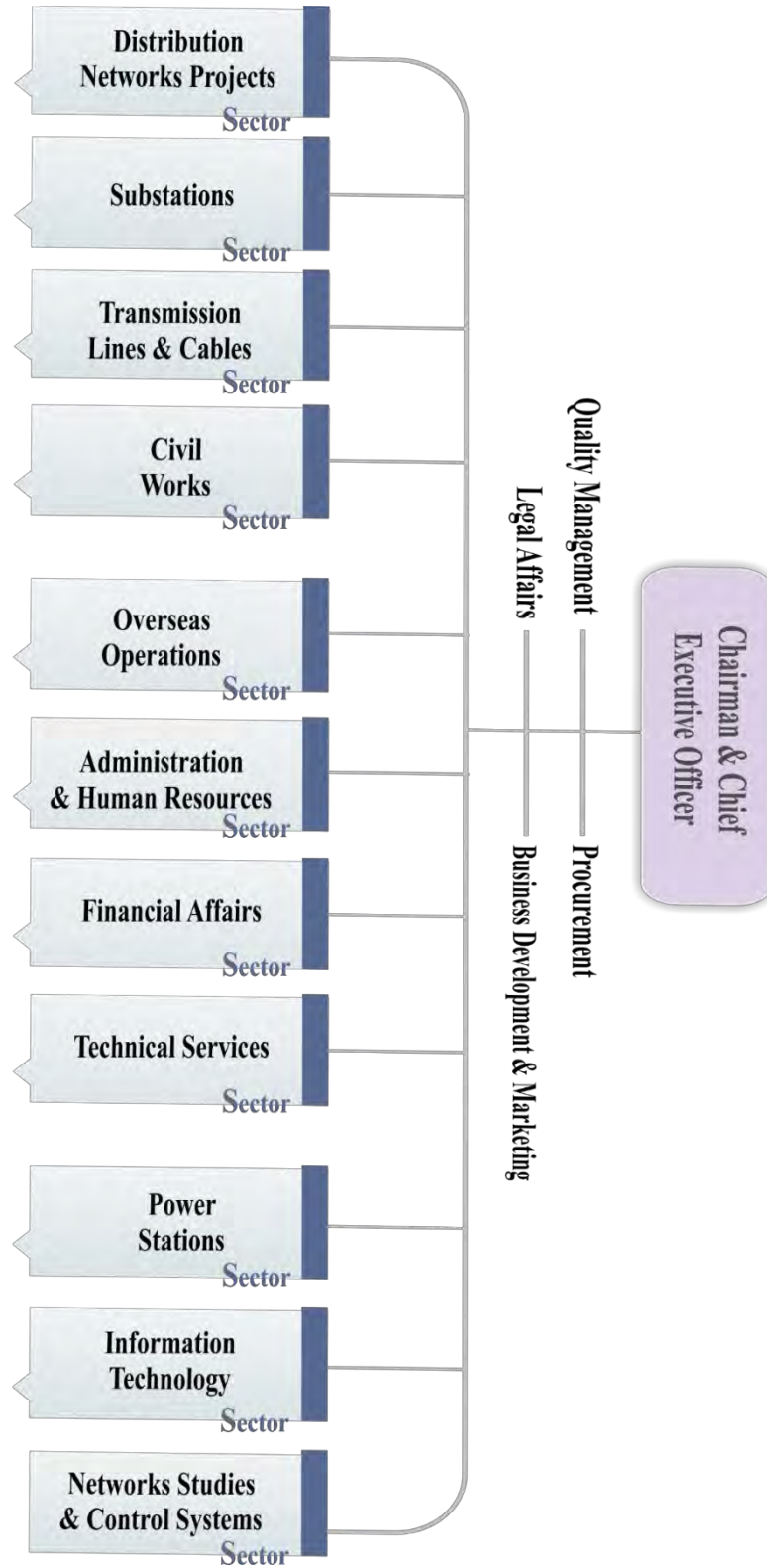

KEY PERSONNEL



EPS is managed by highly experienced group of managers. The key personnel are:

<i>Name</i>	<i>Position</i>
Eng. Elhussieny ElFar	Chairman and Chief Executive Officer
Eng. Asmaa El-Desouky	Substations, Sector Head
Eng. Osama El-Matarawy	Distribution Networks, Sector Head
Eng. Mohamed Saad	Civil Works, Sector Head
Eng. Hasan Negem	Transmission Lines & Cables, Supervisor of Sector Head
Eng. Azza Khalil	Networks Studies and Control Systems, Sector Head
Eng. Nevien Khadr	Information & Applications Automation, Sector Head
Eng. Rabea Zayed	Power Station Projects, Sector Head
Eng. Soha Zakaria Sharaf	Overseas Operation Sector, Sector Head
Eng. Hatem El Ghorory	Business Development Sector
Mr. Mohamed Mekhemer	Admin. & Human Resources, Sector
Acc. Osama Abd El Raouf	Financial Affairs, Sector

Ownership

EPS shares are held and equally divided between the following Authorities and Companies:

- ⌚ Egyptian Electricity Holding Co.
- ⌚ Nuclear Power Projects Authority
- ⌚ Hydro Power Plants Authority
- ⌚ Cairo Electricity Distribution Co.
- ⌚ Alexandria Electricity Distribution Co.
- ⌚ El Nasr Transformers & Electrical Products CO.
- ⌚ High Dam Electric & Industrial Projects Company.
- ⌚ Misr Company for Mechanical and Electrical Projects.

The first six shareholders are owned by the Ministry of Electricity and Energy; the next shareholder is affiliated with the Ministry of Public Sector, while the last shareholder is a Privately-Owned Company.



Major Organizations Recognizing EPS

EPS Company is recognized as a Consulting Firm by the agencies given below:

- The World Bank
- The African Development Bank.
- The Arab Fund for Economic and Social Development.
- The Islamic Bank
- Kreditanstalt für Wiederaufbau (KfW)
- The United Nations Development Program
- The Commission of the European Communities
- European Investment Bank (EIB).

EPS is also a member of the Egyptian Syndicate of Engineers and the Federation of African Consultants

Contracts Share from 1/01/2021 till end of 2021

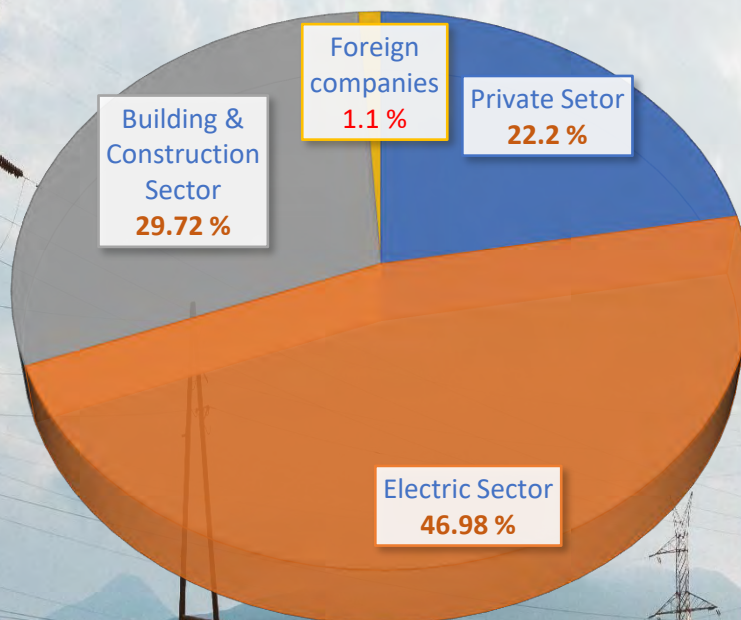

Activities and Services

Fields of Activities		Services
Distribution Networks	<ul style="list-style-type: none"> ○ Distribution Networks Projects ○ Rural Electrification Networks ○ Urban Supply Networks 	<ul style="list-style-type: none"> - Distribution Networks ○ Load Research and Load Forecasting ○ Field Measurements ○ M.V. and L.V. Networks Design ○ Short Term and Long Term Plans ○ Indoor & Outdoor Lighting ○ Optimization of Losses ○ Protection Coordination ○ Supervision for all Elements of Electrical Distribution Networks
Substations	<ul style="list-style-type: none"> ○ Substations up to 500/220KV, 220/66KV, 66/22/11KV 	<ul style="list-style-type: none"> - Substations ○ Engineering Services ○ Protection Coordination ○ Substation Control System ○ Switching Stations ○ Substation Interconnection ○ Communication System ○ Procurement Services ○ Project Management ○ Construction Supervision Services
Transmission Line & Cables	<ul style="list-style-type: none"> ○ Transmission Lines up to 500Kv ○ Power Cables up to 220KV 	<ul style="list-style-type: none"> - Transmission Lines & Cables ○ Towers Electrical Design ○ Towers Spotting ○ Surveying Works ○ Soil Mechanics ○ Procurement Services ○ Construction Supervision

Activities and Services

Fields of Activities	Services	
Civil Works	<ul style="list-style-type: none"> ○ Design of Steel and Concrete Structures ○ Procurement Activities ○ Construction Supervision 	<ul style="list-style-type: none"> - Civil Works ○ Design & design review of steel structures for overhead transmission towers up to 500KV. ○ Design & design review of telecommunication towers up to 120-meter height. ○ Design & design review of civil works for substation GIS and AIS types up to 500KV include detailed design and shop drawings for control and switchgear buildings, transformers foundation, outdoor equipment supports, trenches and roads. ○ Prepare BOQ and material list structure and architecture items ○ Design reports and provide solution for the upgrade of existing overhead transmission lines, include steel towers and foundations repair and stiffening
Power Station Projects	<ul style="list-style-type: none"> ○ Steam Plants ○ Gas Turbine Plants ○ Combined Cycle Plants ○ Diesel Plants ○ Hydro-Electric Plants ○ Wind Farms ○ Solar PV and CSP ○ Feasibility Studies 	<ul style="list-style-type: none"> - Power Station Projects ○ Studies and Project Investigations ○ Engineering Services ○ Procurement Services ○ Project Management ○ Construction Supervision ○ Operational and Maintenance Management
Overseas Operations	<ul style="list-style-type: none"> ○ Substations ○ Transmission lines ○ Civil Works ○ Distribution networks ○ Power systems studies 	<ul style="list-style-type: none"> - Overseas Operations ○ Technical & Financial Offers ○ Conduct Contract Agreement ○ Prepare the Contracts documents ○ Project Management & Construction Supervision ○ Coordination between company participated sectors - Assigning EPS Experts for Specific Jobs

Activities and Services

Fields of Activities	Services
<p style="text-align: center;">Networks Studies and SCADA Control Systems</p> <p>1- Network Studies</p> <p>2- Detailed Engineering design for substations</p> <p>3- Control Systems</p>	<p>1) Network and Technical Studies</p> <ul style="list-style-type: none"> ○ Interconnection of new and existing substations/power stations studies ○ Feasibility studies ○ High, Extra high and medium voltage network planning studies ○ Load forecast & development of distribution network ○ Power quality study ○ Grid impact studies for renewable energy (wind and solar energy) <p>2) Detailed Engineering Design Services</p> <ul style="list-style-type: none"> a) Primary Engineering. b) Secondary Engineering c) Electromechanical <p>3) Control Systems</p> <ul style="list-style-type: none"> a) Distribution Control Centers b) Regional Control Centers c) Telecommunication and Control Systems
<p style="text-align: center;">Information & Applications Automation</p> <ul style="list-style-type: none"> ○ Business Modeling ○ Professional Support Systems ○ Management Information Systems and Management Support Systems ○ Computer Networks (LAN, WAN) ○ Billing Systems ○ Geographic Information Systems ○ ERP ○ CRM ○ Hospital Applications 	<ul style="list-style-type: none"> - Information & Applications Automation ○ Business System Architecture Modeling ○ S.W Engineering ○ Networking ○ Testing ○ Implementation ○ Web Design ○ High availability Solutions ○ Geographic Information Systems



DISTRIBUTION NETWORKS

Projects served till the end of 2021 = **4140** Projects

 dis-st@eps-egypt.com



Scope of work

- ⚡ Planning & Design supervision electrical networks for agricultural lands
- ⚡ Planning & Design of Distribution networks for new cities
- ⚡ Rehabilitation of distribution networks for rural areas
- ⚡ Power factor measurements and how to improve

Projects served

Distributed among the following activities

- ⚡ Planning and Design of M.V. for main Electrical Networks for East Owinat
- ⚡ Planning, Design & Supervision of erection for internal electrical networks covery for **22** plants (10000 Fed for each Plant) at East Owinat
- ⚡ Planning & Design of Distribution Networks for **27** New Cities
- ⚡ Design of Electrical Power Supply of **3800** Factories
- ⚡ Rehabilitation of Distribution Networks for **35** Rural Areas
- ⚡ Planning and Design of M.V. for main Electrical Networks for Toshka
- ⚡ Electrical Supply Networks for **3** High – Riser Buildings
- ⚡ Power Factor Improvement for **51** Plants
- ⚡ Preparation of opacification for led luminaires and approved & kinds of luminaire for all street lighting networks
- ⚡ Others **200** Projects



Planning & Design of M.V for
Electrical Networks for East Owinat



Consu... east
Television Building (Maspero)

Major Projects

Interconnection Owainat East with the Electric National Grid

- ⚡ Electric Distribution Networks for 22x10000 Feddan including 2000 km of 22 kV and 300 km of 0.4 kV Low Voltage Networks

Completion Date 2021



OverHead Transmission Lines 22kV

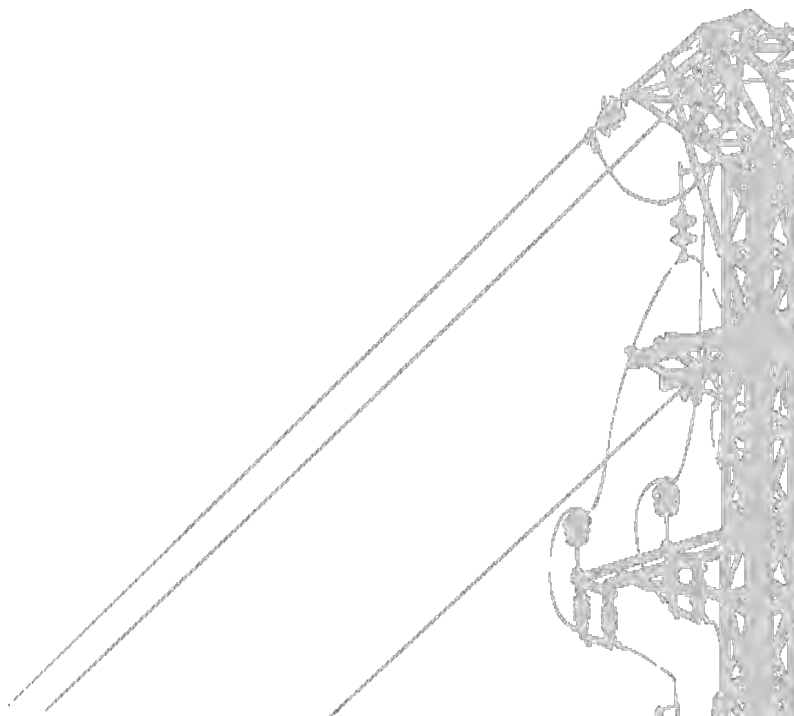



Go Through the Future



SUBSTATIONS

Projects served till the end of 2021 = **255** Projects

 sub-st@eps-egypt.com



Scope of work

- ⚡ Project study and design
- ⚡ Feasibility study
- ⚡ Bid Documents Preparation
- ⚡ Bids Evaluation
- ⚡ Prepare Technical Evaluation report with recommendation
- ⚡ Prepare Final evaluation report with recommendation
- ⚡ Prepare contract documents
- ⚡ Project Management
- ⚡ Detailed design review of the substation
- ⚡ Site Supervision of construction, testing & commissioning till handing over

Projects served

Distributed among the following voltage levels

500	kV S/St's	30
380	kV S/St's	5
220	kV S/St's	66
132	kV S/St's	4
66	kV S/St's	80
Studies	kV S/St's	70

Zahraa El Maadi
500/220/22 AIS (3*500 MVA)



Major Projects

16 Project Financed from EIB (European Investment Bank)

- ⚡ (9) S/St's 500/220/22 kV
- ⚡ (7) S/St's 220/66/22 kV



Suez Gulf 500/220 KV GIS
Substation 1x500 MVA



Badr 500/220/22 GIS S/St 3x500 MVA



Zahraa El Maadi 500/220/22 AIS (3*500 MVA)

4 Project Financed from WB (World Bank)

- ⚡ (2) 500/220/22 kV GIS S/St
- ⚡ (2) 220/66/22 kV S/St

4 Project Funded by Arab Fund for Economic and Social Development

- ⚡ West Demietta 500/220/22 kV GIS S/S
- ⚡ El-Eqtsadiya 500/220/66/22 kV GIS S/S
- ⚡ El-Hawamdiya 500/220/66/11 kV GIS S/S
- ⚡ 220 kV Extension of Damitta (1) 66/11 kV GIS S/S

Strategic National Projects

Owainat East Project

- ⚡ 220/66/22 kV Substation 2x125 MVA + 3x25 MVA
- ⚡ 2 Substations 66/22, 3x25 MVA each
- ⚡ Berket Ghlion 66/11 kV substation
- ⚡ United factory 66/11 kV substation

Medium voltage

Switchgear



25 MVA Transformers



125 MVA 220/66/11

Transformers



Private sectors S/St

- ⚡ Watania 220/66/22 kV GIS Substation project

- ⦿ Two Substation Egyptian American Steel Rolling 220/30/11 KV S/ST (Beshay Steel)
- ⦿ El Marakby Steel 66/33/22 kV S/ST
- ⦿ Cairo Festival City Project S/ST
- ⦿ Two S/ST El Massrieen Steel factory 220/33/22 kV
- ⦿ Medcom Aswan factory 220 kV S/ST
- ⦿ More than 5 S/S's for Cement factories
- ⦿ Barwa 1&2 66/22 kV Substation project
- ⦿ Damac 1&2 66/22 kV Substation project



United 66/11 kV Substation



Conventional Indoor 66 kV Equipment

- ⊗ El Motawreen 66/22 kV Substation project
- ⊗ El Hay El Motamyez 220/66/22 kV GIS Substation project
- ⊗ Sonker 66/22 kV Substation project
- ⊗ El Marakby steel 66/22 kV Substation Extension project
- ⊗ New Heliopolis 66/22 kV Substation project
- ⊗ New Mansoura 220/22/22 kV
- ⊗ Taqa S/ST 220/22/22 kV
- ⊗ Canal Sugar Factory Project S/ST 220/33 kV at AL- Minya
- ⊗ S11 66/11 kV AIS Substation Project
- ⊗ S13 66/11 kV AIS Substation Project
- ⊗ New East Port Said 66/22 kV AIS S/S
- ⊗ Ayat 66/11 kV AIS Substation
- ⊗ Capital Gardens 220/22/22 kV GIS S/S



**Wadi Sa'a
132/33 KV GIS Substation**



- ⊗ October / El-Seniya 66/22 kV AIS S/S
- ⊗ El-Obour 5 220/66/22 kV GIS S/S
- ⊗ Badr 2 220/66/22 kV GIS S/S
- ⊗ Naser Asuit 66/22 kV AIS S/S
- ⊗ Industrial Zone 66/22 kv AIS S/S
- ⊗ East Qena 66/22 kV Temporary S/S

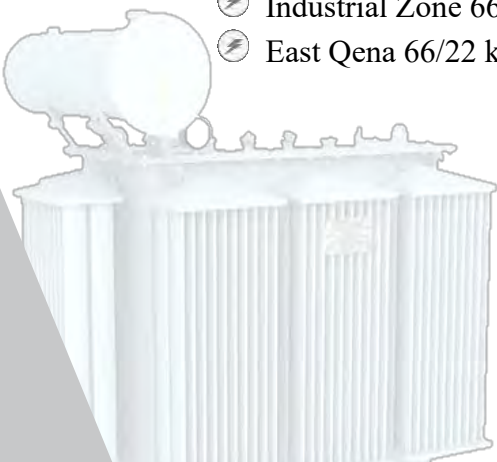

- ⚡ Iskan Gamaeat 66/22 kV AIA S/S
- ⚡ New Alameen 220/22/22 kV GIS S/S
- ⚡ New Qena 66/22 kV AIS S/S
- ⚡ Badr 3 66/22 kV AIS S/S
- ⚡ 8th Industrial of Alsadat City 220/22/22 kV GIS S/S
- ⚡ 6th October Eastern Extensions 220/22/22 kV GIS S/S
- ⚡ 6th October Northern Extensions 220/22/22 kV GIS S/S/Sal-Emtdad of El-Sadat City
220/22/22 kV AIS S/S
- ⚡ Damietta (2) 66/11 AIS S/S
- ⚡ Dry Port of 6th October Extension 220/22/22 kV S/S



New Ghobrah
132/33/11 KV GIS S/St



Main AC/DC Relay
Sub AC/DC





Go Through the Future

OVERHEAD TRANSMISSION LINE & CABLES

Projects served till the end of 2021 = **790** Projects

 ohntl@eps-egypt.com



Scope of work

We design, manage and supervise the construction of transmission projects; we have successfully engineered many complex projects, providing the best solutions for transmission problems. Our scope includes but not limited to the following:

- ⚡ Survey and geotechnical investigations
- ⚡ Complete designs for Overhead Transmission lines using the most powerful software packages known in the business
- ⚡ On site supervision of Transmission and Distribution Projects
- ⚡ Design and supervision of Underground Cable installations for high and medium voltage projects
- ⚡ Preparation of tender/contract documents as well as tender evaluation, technically and financially
- ⚡ Studies for upgrading and rehabilitation the aged High Voltage and Medium Voltage networks
- ⚡ Planning, feasibility studies and selection for the best economical and technical solutions for new and existing Overhead Transmission Lines

Projects served **29264 km**

Distributed among the following voltage levels

500	kV T.L	9720	Km
400	kV T.L	1470	Km
380	kV T.L	950	Km
220	kV T.L	11280	Km
132	kV T.L	400	Km
66	kV T.L	4640	Km
34.5	kV T.L	70	Km
220	kV Cables	10	Km
66	kV Cables	1145	Km
11	kV	216	Km



500 kV Double Circuit Tower



500 kV Single Circuit Tower



Abu Qir/ Kafr El Zayat/ Bassous
- 193 Km 500 kV



Multi Circuits Towers Approach
to El-Siouf Substation

Major Projects

Zahraa Maadi Interconnection

- ⚡ 500 kV OHTL South Helwan/Zahraa El Maadi

Completion Date 2018

Single Circuit OHTL Abu Qeer/ Badr 500

- ⚡ Total Length 344 km

Completion Date 2015



Owinat New 220 kV

- ⚡ Double circuit Main Owinat , total length of 65 km

Completion Date 2/2021

Double Circuit OHTL Samalut / Suez Gulf 500 kV

⚡ Total Length 257 km

Completion Date 2017



Double Circuit OHTL Tebben / Kurimat 500 kV

⚡ Total Length 155 km

Completion Date 2019

Double circuit Owinat New/ Gabal El-kamel 66 kV

⊕ Total Length 30 km

Completion Date 2/2021

- Study crossing of 66 kV & 220 kV OHTL with Monorail route.
- Study crossing of 66 kV & 220 kV OHTL with Electrified train route

- Design H.V. UG cable of Buffer Zone in the Administrative Capital for Urban Developments (ACUD).
- Design and Execution Supervision of OHTL & UG cables for the New Urban Developments (NUCA) at New Al-Alamine , New Mansoura, El-sadat, Badr , 10th of ramadan and El-Obour.
- Survey & Design of Wadi Hadramout (Republic of Yemen) for 132 kV OHTL (30 km).



Go Through the Future



CIVIL WORKS

Projects served till the end of 2021 = **473** Projects

 civil@eps-egypt.com



Scope of work

EPS civil sector provides consultancy services for the structure and architecture design, preparation of technical specifications and tender documents, projects management, construction supervision especially for substations up to 500 KV, power generation, OHTL towers up to 500 KV and telecommunication towers.

Services provided are given a competitive advantage as we apply the latest method of technology in the engineering by using the latest international computer systems and program, the scope of services include but not be limited to the following:

Engineering service

- ⊗ Detail design of architecture and structure for substations (66, 220, 500 kV).
- ⊗ Steel structure design of over Head transmission towers for 66, 220 and 500kV
- ⊗ Steel structure design for Gantries and Equipment supports.
- ⊗ Detail design of foundations for O.H.T towers.
- ⊗ Design of service roads for renewable energy projects of wind farms and solar energy plants.
- ⊗ Preparation of work shop drawings for all architecture and structure drawings.
- ⊗ Technical and structure studies for strengthening of existing O.H.T steel towers.

Construction supervision

- ⊗ Supervision of foundation work for O.H.T.L.
- ⊗ Coordination between different contractors.
- ⊗ Material inspection and testing.
- ⊗ Follow up all construction activities with respect to project schedule.

Projects served **473** Projects

Distributed among the following activities

Overhead Transmission Line Projects	334
Substations Projects	66
Telecommunication Towers Project	31
Distribution Panels & Services Buildings Projects	36
Consultancy Services for Industrial Projects	6



Design & Construction Supervision
Of MicroWave Towers



Loading test for Towers



Deep Foundations (Piles) for OHTL



Foundation for OHTL



High Voltage testing station
Repair of Steel Structure
& Foundation



Offshore Towers

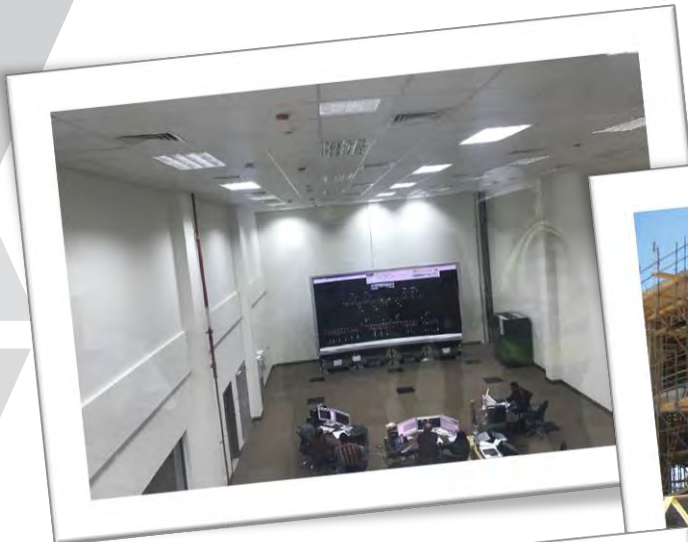

Control Center



**Adjustments of embedded parts
by template**





Core Test for Quality control



Test for soil compaction



Soil replacement and compaction



Plate Load Test on Soil Replacement



Go Through the Future



POWER STATIONS PROJECTS

Projects served till the end of 2021 = **73** Projects

 powgen@eps-egypt.com



Scope of work

Power stations services cover

- ⌚ Feasibility Studies & Project Investigations
- ⌚ Engineering Services
- ⌚ Procurement Services
- ⌚ Project Management & Construction Supervision
- ⌚ Operation & Maintenance Services
- ⌚ Maintenance Management systems

Total Generation Capacity Served

Distributed among the following types of Power Stations

- ⌚ **Steam Power station**
- ⌚ **Gas Turbine Power station**
- ⌚ **Diesel Power station**
- ⌚ **Combined Cycle Power station**
- ⌚ **Feasibility Studies**
- ⌚ **Co-Generation Power station**
- ⌚ **Hydraulic Power station**
- ⌚ **Wind Farms**
- ⌚ **Solar PV & CSP**

1- Steam Power stations:

14 Projects with a total power reached **7535 MW**

2- Gas turbine and Combined Cycle power stations:

7 Gas turbine projects 7 combined cycle projects with a total power reached **5775 MW**

3- Diesel Power Stations:

12 Projects with a total power reached **84.9 MW**

4- Co-Generation Power stations:

Two Projects with a total power of **26.3 MW**

5- Hydraulic Power stations:

5 Projects with a total power reached **169.3 MW**

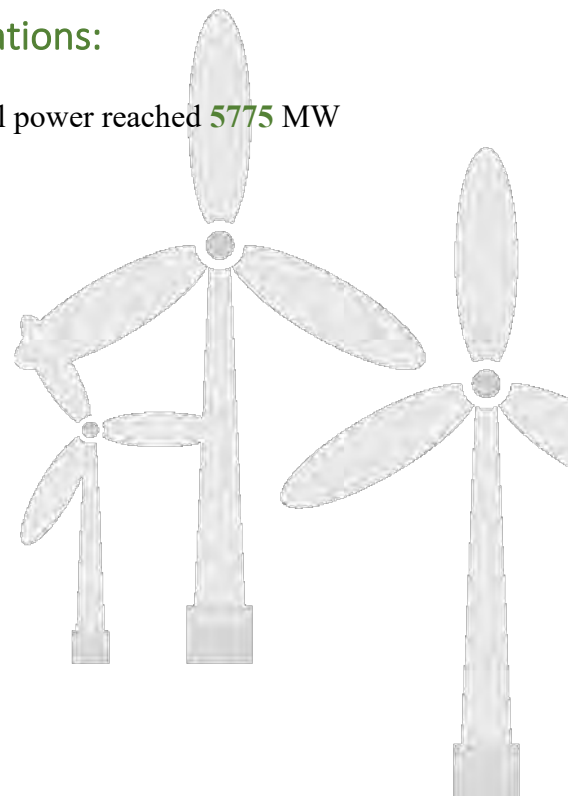

6- Wind Farm:

13 Projects with a total power of **2265** MW distributed as follow: -

- ⊗ NREA/DANIDA Zafarana Wind Farm Phase I (**30** MW)
 - ⚡ The project comprises **50** units of **600** kW. The units are running now.
 - ⊗ NREA/DANIDA Zafarana Wind Farm Phase II (**30** MW)
 - ⚡ The project includes **46** units of **660** kW. The farm is running now.
 - ⊗ NREA/KFW Zafarana Wind Farm Phase I (**33** MW)
 - ⚡ The farm is consisting of **55** wind energy converters of **600** kW.
 - ⚡ The units are running now.
 - ⊗ NREA/KFW Zafarana Wind Farm Phase II (**47** MW) The project comprises **71** units of **660** kW the units are now running.
 - ⊗ Spanish **85** MW wind farm. EPS acted as main consultant for all local works. The project comprises **100** turbines of **850** kW each.
 - ⊗ Kfw IV Zafarana **80** MW wind farm. EPS acted as sub-consultant with LI as main consultant. The project comprises **94** turbines of **850** kW capacities each.
 - ⊗ JBIC Wind Power Plant Project at Zafarana (**120** MW) – NREA sub-consultant with Decon. The project comprises **142** turbines of **850** kW capacities each.
 - ⊗ JICA **220** MW Wind Farm Power Plant at Gabal El-Zeit as Subconsultant to Lahmayer in the field of MV and LV network and carry out the feasibility study.
 - ⊗ **250** MW BOO Wind Power Plant Project at Ras Ghareb as a Consultant for the main contractor (Orascom Construction).
 - ⊗ **500** MW Consultancy services agreement with NREA for operation and maintenance of the wind farms at Zafarana in order to improve the availability and productivity of the plant.
 - ⊗ Consultancy services for Orascom construction (Main contractor) ,500 MW BOO Wind Power Plant project at Ras Ghareb (running).
 - ⊗ 250 MW Wind Farm at Gulf Suez, Ras Ghareb – NREA- sub consultant with Tractebel (running).
- ⊗ EPS rendered feasibility studies for the following project: -
 - ⚡ 120 MW Italgem Wind Farm at Gulf El Zeit.

7- Solar Energy:

EPS had signed joint venture agreements with the following entities: -

- ⊗ British University Egypt (BUE).
- ⊗ Solar Technology Advisor (STA).
- ⊗ Engcotec Advanced Technology – Prof Dr. Ibrahim Samak.
- ⊗ New and Renewable Energy Authority (NREA).
- ⊗ NOKRASHY Engineering GmbH Prof. Dr. Hany El Nokrashy.

In the field of Solar Power Stations Project.

- ⊗ Provide consultancy services for operation and maintenance of Kureimat thermal solar power plant **140** MW for NREA.
- ⊗ EPS were sub-consultant for the Engineering Services for Kureimat Solar Power Station (**140** MW) with the German Consultant Fitshner.

- ⦿ EPS completed the project of installing **10** KW PV solar over its Building at Sheraton Heliopolis.
- ⦿ EPS has been assigned to be the independent engineer for the feed in Tariff (FiT) PV power projects at Benban **1800** MW and Zaafarana **305** MW with a total power of **2105** MW.
- ⦿ EPS is the main consultant to carryout the consultancy services including the detailed design for **3** plots with total power of **165** MWp PV, FiT power plants at Benban.
- ⦿ EPS was selected by Egyptian Transmission Company as a short list with STA for offering consultancy services for **200** MW at Kom Ombo.
- ⦿ EPS provided support to Egyptian Electricity Transmission Company (EETC) for technical analysis and evaluation of the contractor's proposals in the field of wind farm and PV solar projects at Egypt with a capacity reaches **4300** MW BOO Projects.

8- Feasibility studies:

- ⦿ EPS prepared a study to develop the performance evaluation for electric production companies in the Arab Republic of Egypt and determine the target values for the operation key performance indicators according to international standards for the benefit of the Electricity utility and consumer protection Regulatory Agency.
- ⦿ EPS performed pre-feasibility studies for PV solar system at Canal Electric Distribution Company.
- ⦿ **5** MW Co-generation project KC textile factor at 10th, of Ramadan City.
- ⦿ EPS/Engcotec achieved the following activities in the first stage of New Touthka City (5000 KWp solar PV) project:
 - ⚡ Performing the feasibility study.
 - ⚡ Prepare the study of interconnection the solar park with the unified grid.
 - ⚡ Preparing the tender documents for the project
 - ⚡ Assist the Owner (NUCA) in the evaluation of the contractor offer.
- ⦿ The scope of EPS/Engcotec will also include the following tasks for the above project of New Touthka City:
 - ⚡ Supervision of erection and commissioning
 - ⚡ Prepare the provisional Acceptance Certificate (PAC)
- ⦿ EPS prepared the feasibility study for **20** MW and **50** MW CSP for the Owner (NUCA).



Al korimat Solar Thermal Power Stations



Zafarana Wind Farms



Karama Power Plant



Damietta Combined Cycle Power Station



PV Solar power stations



ESNA Hydro Power Plant

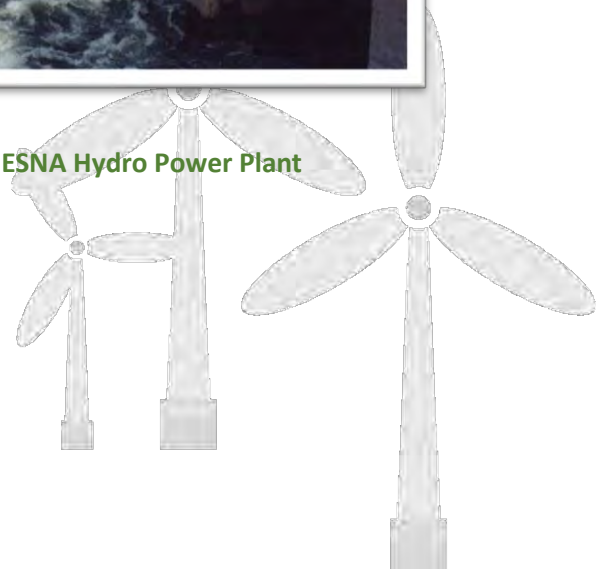

Major Projects

South Sudan

- ⊗ Electric Power Station of
- ⊗ Electric Power Station of

Bor City
Yambio City

2.4 MW
2.4 MW



Yambio Power plant over View



Bor Power Plant Main Entrance

- ⊗ Electric Power Station of
- ⊗ Electric Power Station of

Rombik City
Wau City

2.4 MW
2 MW

Completion Date 2012



Wau Power plant over View



Diesel engines inside engine hall

Owainat East Project

⚡ 3 Electric power stations 4 MVA each

Completion Date 2012



Diesel engines inside engine hall



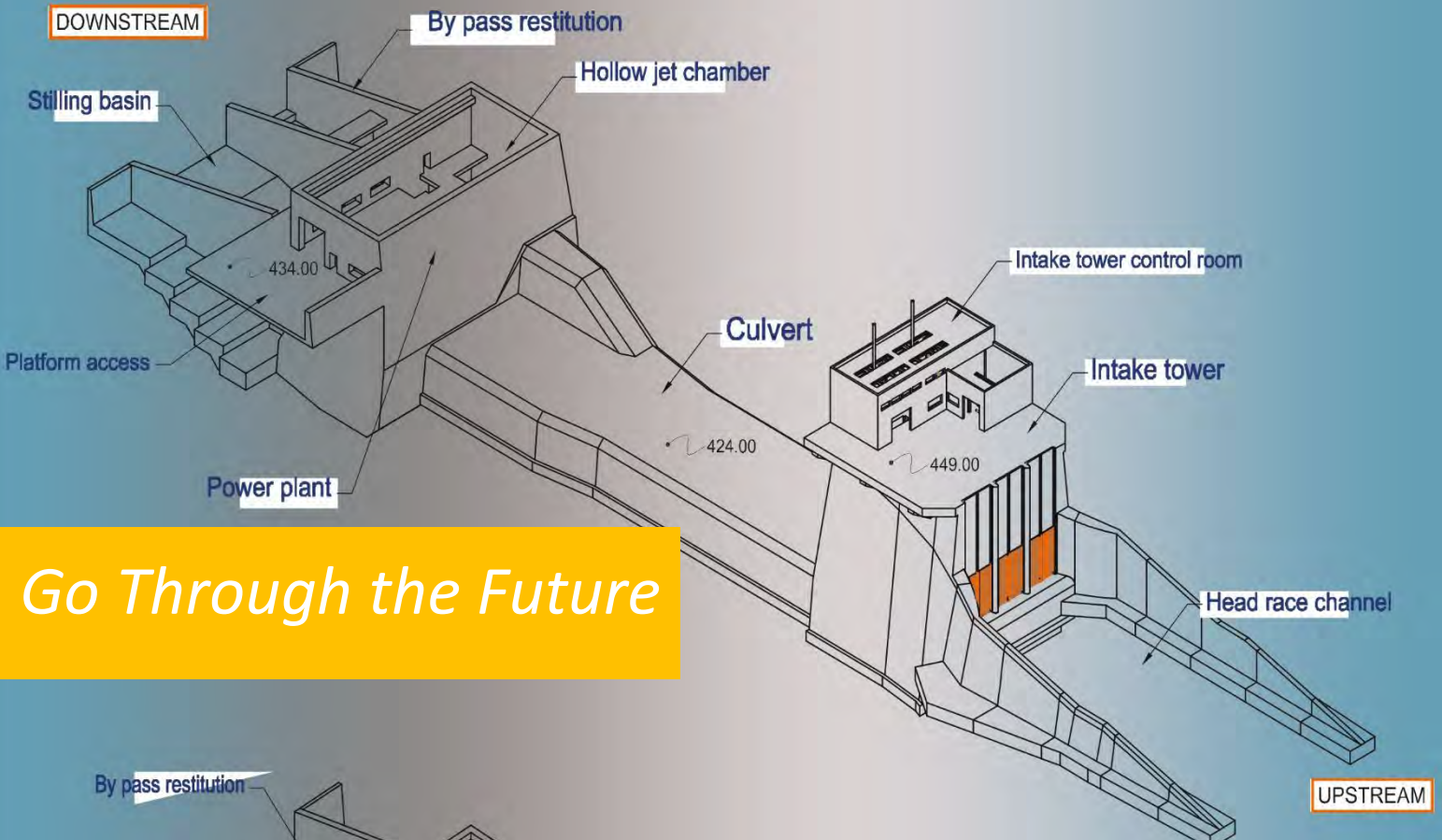

Go Through the Future

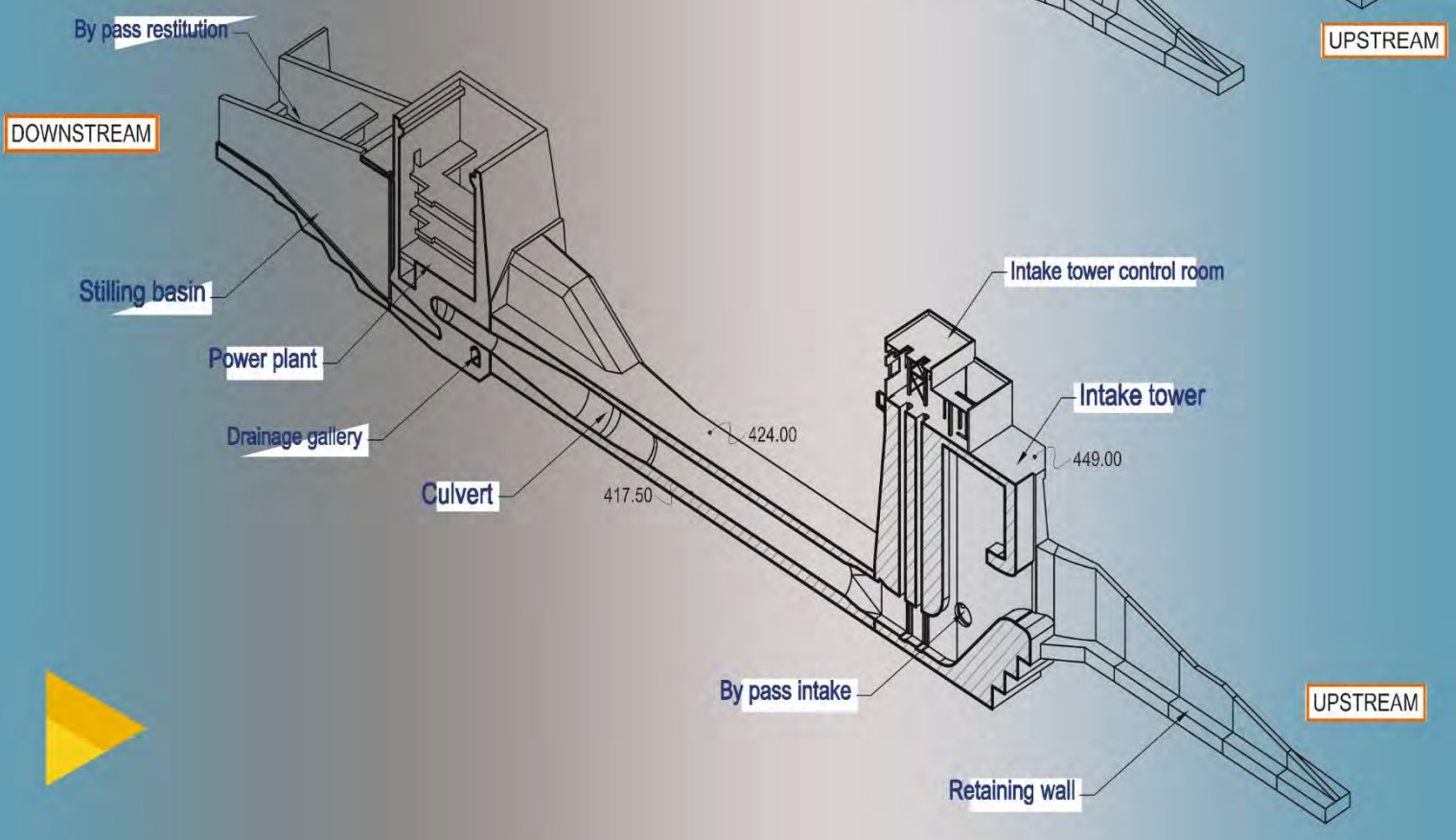



OVERSEAS OPERATIONS

Projects served till the end of 2021 = **26** Projects

 overseas@eps-egypt.com



Scope of work

- ⌚ Conduct Pre-feasibility Study & Feasibility Study.
- ⌚ Study and prepare technical and financial tender documents according to client TOR.
- ⌚ Design of reinforced concrete structures and reinforced concert deep and shallow foundations for Substations, Power Generation & OHTL's.
- ⌚ Prepare contract documents between the client and EPS.
- ⌚ Prepare contract documents between the client and successful bidders.
- ⌚ Project management and construction supervision
- ⌚ Coordination between company participated sectors
- ⌚ Conduct contract / progress meetings
- ⌚ Assign EPS experts to participate for providing engineering services for specific jobs.
- ⌚ Provide required assistance to the client during guarantee period
- ⌚ Setting KPI (key Performance Indicator) to measure the implementation of contracted work.
- ⌚ Technical consultant for supervision & monitoring for facility management contractor (FMC).
- ⌚ Independent Engineer, Report to stakeholders the status, progress & achievement of milestone.
- ⌚ Independent Engineer To attend Operating Committee meetings

Overseas Projects

- ⌚ Providing Consultancy Services to Oman Electricity Transmission Company (OETC) in Sultanate of Oman, Qatar General Electricity and Water Corporation (KAHRAMAA) in Qatar, Saudi Electricity Company (SEC) in Kingdom of Saudi Arabian, Dubai Electricity Water Authority (DEWA) in United Arab of Emirates, Republic of South Sudan Government, Burundi Government, General Electrical Company Of Libya (GECOL) in Libya and Algerian Energy Company (AEC) in Algerian for Substations, Transmission Lines, Civil Works, Distribution Networks and Power Systems Studies Projects.
- ⌚ **Independent Engineer for infrastructure (substations, OHTL, underground cables, Local monitoring center, roads around the site (ring road) & internal roads.**
- ⌚ Reporting to Stakeholders on the state of completeness of the relevant Infrastructure Works.
- ⌚ Determining whether the infrastructure works milestones have been achieved.
- ⌚ **Independent Engineer To attend Operating Committee meetings.**

- ⦿ Review and agree the matters relating to the construction, commissioning, operation and maintenance of the Project.
- ⦿ **Technical consultant for supervision & monitoring of facility management.**
- ⦿ Coordinating with the FM contractor to set time schedule for Monitoring and Supervision.
- ⦿ Setting KPIs to measure the implementation of contracted works for each activity.
- ⦿ Supervision of implementation of Contractor works.

Major Projects

Independent Engineer for PV Power Project at Benban

Running

Technical Consultant (TC) for Supervision & Monitoring of Facility Management Contractor During Construction and O&M phase

Completion Date 2019

Independent Engineer for RA SOLAR S.A.E.

Completion Date 2018

Independent Engineer for Lekela
Egypt Wind Power BOO S.A.E-
Running



Technical Consultant (TC) for Lekela
Egypt Wind Power BOO S.A.E
Running



South Sudan

- ⚡ **Electric Distribution Network of Wau City** 15 MW 11 kV



Completion Date 2012

- ⚡ **New Wau Hydropower on Sue River Dam with capacity 10.4 MW**

Completion Date 2014

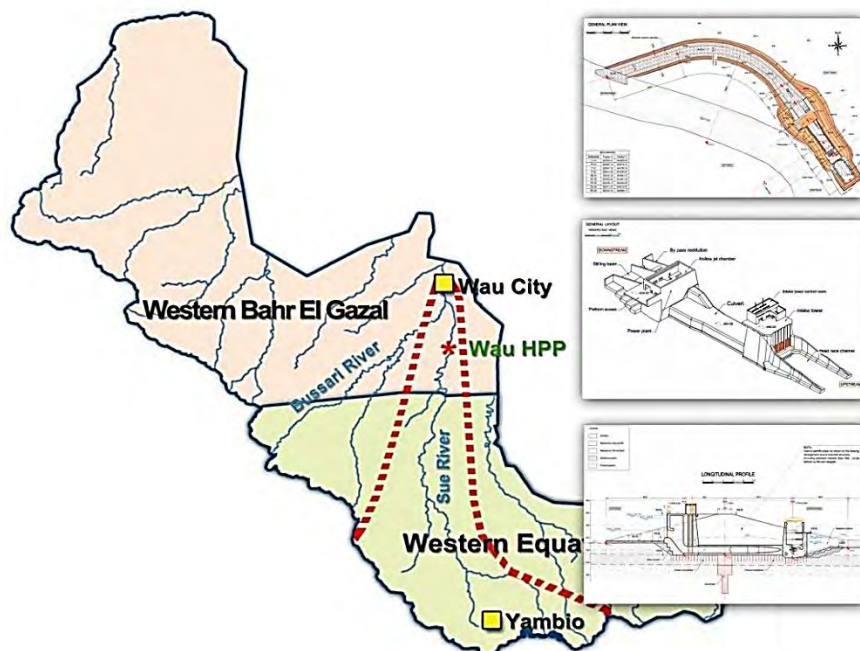

Substation & Transmission Line Oman



Power Generation & Distribution Sudan



Burundi

Pre-feasibility study for kirasa hydropower project in republic of Burundi

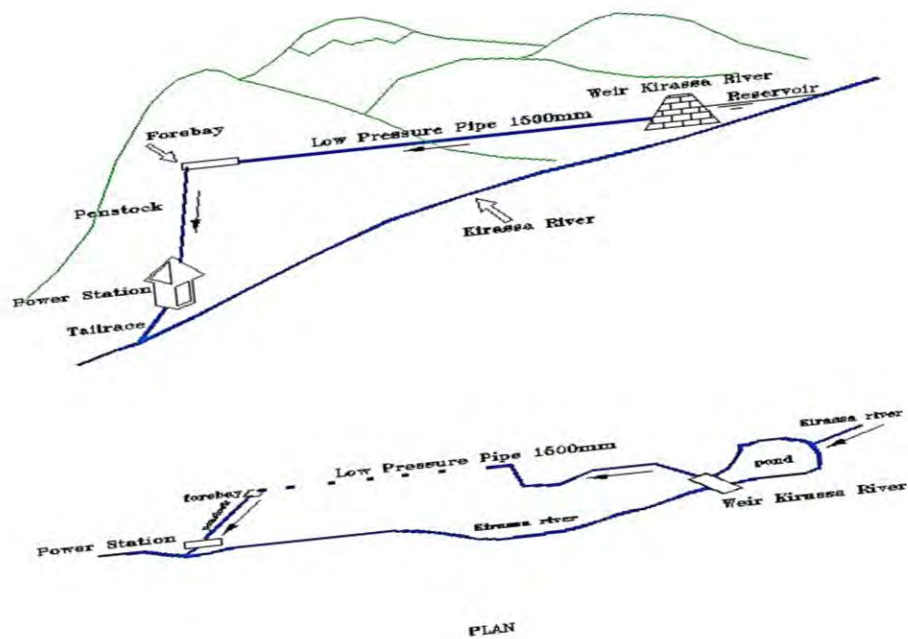

PLAN

DATE	APPROVED	DESIGNED	DRAWN	CHECKED	PROJECT NO.	SHEET NO.	TOTAL SHEETS
15/05/2011	[Signature]	[Signature]	[Signature]	[Signature]	001	1	1
EPS				Option 3 Pipe Line System		ORDER NO. ORDER DATE PROJECT NO.	
DRAWING NO.				REV. PROJECT			



NETWORKS STUDIES & CONTROL SYSTEMS

Projects served till the end of 2021= **365** Projects

 syseng@eps-egypt.com



Scope of work

The Networks studies and control system sector including:

- ⊗ Network and Technical Studies
- ⊗ Detailed Engineering Design Services
- ⊗ SCADA, Telecommunication and Control Systems



1. Network Studies

⊗ **Electrical Network Planning Studies**

- Load forecast studies.
- Planning of high voltage, extra high voltage and medium voltage networks including.

Static studies:

- ⚡ Load Flow Calculations Study.
- ⚡ Three Phase and Single-Phase Short Circuit Calculations Study.
- ⚡ Contingency analysis.

Dynamic studies:

- ⚡ Dynamic studies have been performed to assess the system stability and to establish the stability limits following a set of critical faults on the power system. These studies assess the dynamic performance of transmission system modelling.

- Rehabilitation and expansion of electrical power High voltage networks.
- Planning of medium voltage networks including load forecast.

⊗ **Interconnection studies**

Interconnection of new and existing substations/power stations with studies for the power system high voltage (unified network).

⊗ **Interconnection Studies for Renewable Energy Plants**

Study the impact of the connection of wind farm generations as well as the solar plant (Static and Dynamic studies)

Projects:

- ④ Gird Impact Study for Al-Subh Solar Project Plants for Three different plots (including static and dynamic studies) according to the Egyptian Gird Code requirement for 50 MW PV Solar projects in Benban.
- ④ 250 MW BOO Wind Power Plant Project at Ras Ghareb as a Consultant for the main contractor (Orascom Construction).
- ④ Study the influence of the interconnection of Masder (200 MW) Wind Farm to the Unified Power.
- ④ Study the influence of the interconnection of Italgen Wind Farm to the Unified Power System by the year 2013.

2. Detailed Engineering Design Services

The detailed Electrical Engineering includes the following activities:

A. Primary Engineering.

In substation projects, the engineering works related to HV design and general installation part (primary engineering) include the following items:

- ④ Substation general layout & buildings drawing
- ④ Substation civil works guide and sizing parameters (Ex: Loads)
- ④ Power Transformers/Reactors/Capacitor Banks Civil work guide
- ④ Steel structure guide (Equipment Supports & Gantries)
- ④ Earthing Grid Calculation Notes and drawings & Earthing of the equipment
- ④ Lightning Protection Calculation Notes and drawings
- ④ Erection (Installation) drawings to be used by site team
- ④ HV/MV/LV cables routing details
- ④ HV Equipment Specification
- ④ Technical purchasing requirements with detailed BOQ & associated technical specifications for the required material (as Cable Trays/Ladders, HV connectors etc.)

B. Secondary Engineering

In substation projects, the engineering works related to LV system control (Secondary Engineering) include the following items:

- ④ HV/MV Substation Single Line Diagram (S.L.D)
- ④ A/C – 380/220V S.L.D.
- ④ D/C -220V S.L.D.
- ④ D/C-48V S.L.D.
- ④ Protection, Measuring & Metering principle S.L.D.
- ④ Interlocking principle drawings (for AIS S/S).

- ⊗ LV Power Cables Sizing Calculation Notes.
- ⊗ Batteries & Battery charges Sizing Calculation Notes.
- ⊗ Aux. Transformer Sizing Calculation Notes.
- ⊗ LV Power/Control Cables Cable Interconnection & Termination (Cable Book).
- ⊗ A/C – D/C distribution principle.
- ⊗ Technical purchasing requisitions with detailed BOQ & associated technical specifications for the required material (LV power and control cables, cable glands, etc.).
- ⊗ Control & Protection Panel Schematic drawings.
- ⊗ SAS drawings review and interface.

C. Electromechanical

In substation projects, the engineering works related to Electromechanical system include the following items:

- ⊗ Substation lighting system (indoor, outdoor, emergency, .. etc.)
- ⊗ Power sockets and small power (crane, ... etc) system design.
- ⊗ Substation air conditioning & ventilation system.
- ⊗ Outdoor fire hydrant system.
- ⊗ Fire alarm & detection system.
- ⊗ Indoor firefighting system.
- ⊗ Water supply and sewage systems for substation includes indoor & outdoor design, manholes, exact root level of each pipe, water tank and sewage tank.
- ⊗ All related calculations, technical specifications and BOQ

Projects:

- ⊗ Benban (3) 500 kV GIS Substation (500/220/22) kV.
- ⊗ 15th of May (220/66/11) kV GIS Substation
- ⊗ El Narges (220/66/22) kV GIS Substation
- ⊗ 250 MW BOO Wind Power Plant Project at Ras Ghareb as a Consultant for the main contractor (Orascom Construction).
- ⊗ Tameya (220/66/11) kV GIS Substation.
- ⊗ Sharm (220/66/11) kV GIS Substation.
- ⊗ Hurghada (220/66/11) kV GIS Substation.
- ⊗ BenBan (1,2,3&4) substations (220/22) kV.
- ⊗ 165 MW FIT projects PV at BenBan.

Dynamic Stability Simulation

for Load Shedding Study

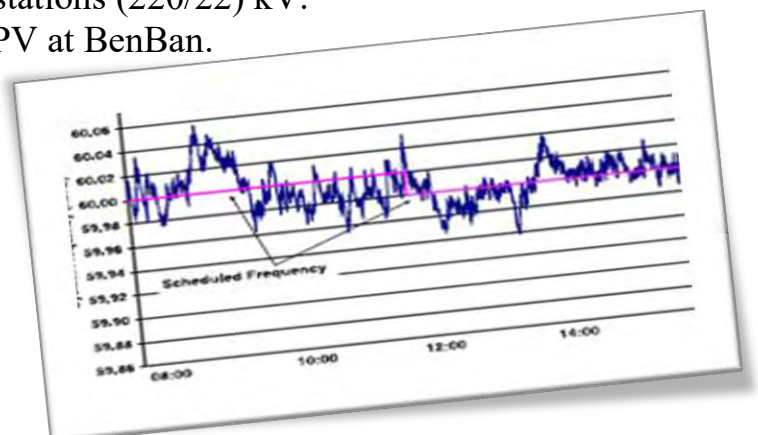

3. Telecommunication and Control Systems

EPS participate in the following control centers as a consultant

A. Distribution Control Center

- ⊗ North Cairo distribution control center
- ⊗ Alexandria distribution control centers (East – West – Middle)
- ⊗ Canal distribution control centers (Ismailia – 10th of Ramadan)
- ⊗ North Delta distribution control center (El-Mansoura)
- ⊗ South Delta distribution control center (Tanta)
- ⊗ Middle Egypt (Menya – Asyut)
- ⊗ Electricity distribution systems improvement projects:
 - ⚡ North Cairo: Helmiya
 - ⚡ North Delta: Damietta
 - ⚡ Alexandria: Borg Alarab

B. Regional Control Centers

- ⊗ Canal Regional Control Centers (CANRCC)
- ⊗ Upgrading Upper Egypt Regional Control Center for Nga Hamady.
- ⊗ Upper Egypt Regional Control Center for Samalout.

Software packages:

⊗ Networks and Technical Studies:

- ⚡ PSS/E Ver.34.5 (Power System Simulator for Engineers)
- ⚡ ETAP Ver.20.0.0(Electrical Transient Analyzer Program)

⊗ In Detailed Engineering Design Services

- ⚡ HAP Ver. 4.9 Hourly analysis program
- ⚡ AutoCAD
- ⚡ Revit
- ⚡ Dialux 4.12
- ⚡ Cymgrd
- ⚡ Cymcap

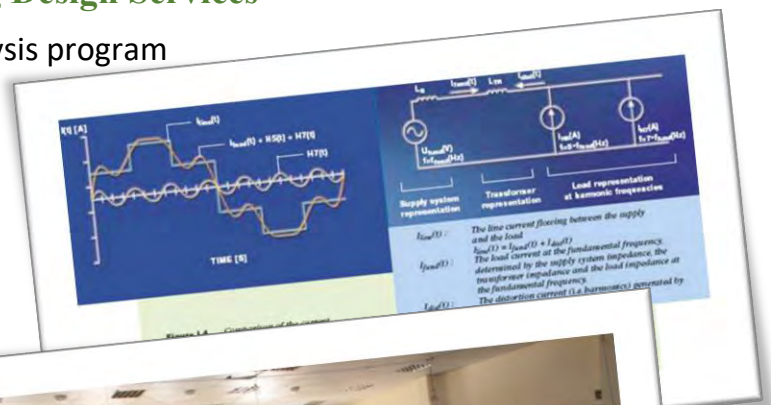

Quality of Supply Study

Measurement of Harmonics

& Design of Filters



Projects served

Distributed among the following activities:

⚡ Interconnection Studies	25
⚡ Feasibility Studies	12
⚡ Protection Coordination Studies	20
⚡ Network Planning	30
⚡ Network Operation Studies	11
⚡ Load Management	4
⚡ Energy Audit	43
⚡ Load Forecast & Development of Distribution Network	26
⚡ Evaluation & Reduction Method for Technical & Non-Technical losses in Distribution Network	39
⚡ Power Quality Study	4
⚡ Energy Efficiency	9
⚡ Protection Coordination Studies for Distribution Network	5
⚡ Electro Magnetic Effect on Pipelines	2
⚡ Outages & Interruption Studies for Distribution Network	1
⚡ Supervision of Installation & Construction of Distribution Network	1
⚡ Voltage drop and power losses studies	1
⚡ Renewable Energy	7
⚡ Wind Farm	5
⚡ Nuclear Power Plant	1
⚡ PV Plant	3
⚡ Other Studies	65
⚡ Detailed Engineering Design for Substations	15
⚡ Distribution Network Control Centers	16
⚡ Regional Control Centers	2
⚡ Communication Networks	3
⚡ Water Network Control Centers	1
⚡ Control Centers Upgrade Studies	4
⚡ GIS/SCADA Interface	2
⚡ SCADA Adaptation (Installation and Testing)	4
⚡ DMS Training	4



Information Technology

Projects served till the end of 2021 = **626** Projects

 itech@eps-egypt.com



The Role

- ⚡ Initiate the project through a development cycle, from initial planning to production based on customer needs.
- ⚡ Developing of Software Integrated Packages (Technical – Financial – Administrative)
- ⚡ Design and Implementation of Integrated Solutions
- ⚡ Supplying of hardware (Servers – PCs – Printers)

Development Methodologies

- ⚡ Software Engineering Development Process
- ⚡ Business Molding
- ⚡ ERD Diagrams for Database
- ⚡ Object Oriented Design
- ⚡ Object Oriented Analysis
- ⚡ Object Oriented Programming

We are providing a Qualified Technical Support Team for Applications and Databases.

Using The latest technologies of Computers, Servers, as well as the latest release of Databases such as Relational DB SYBASE, MS SQL Server, ORACLE, others

Our Mission

- ⚡ Development Software Applications
 - ⚡ Desktop Applications
 - ⚡ Web Applications
 - ⚡ Mobile Applications
- ⚡ Maintained and support Applications
- ⚡ Network solutions
- ⚡ Hardware solutions and implementations



A unified program across Egypt

Unified Electric Meters Readings System

Electric Meters Readings System Is a Uniquely Designed Systems Which aims to record the Electric Meters Readings with high accuracy to reach a valid Electricity bill, nationwide.

The unified Meters reading system aims to eliminate the usual billing errors, record the readings as well, and avoid human errors using the latest technology and sophisticated System Design which enforces the meter reader to take a photo of the meter attached with the meter reader location and immediately send this data to the distribution companies to be validated and approved before issuing the Electricity Bills.

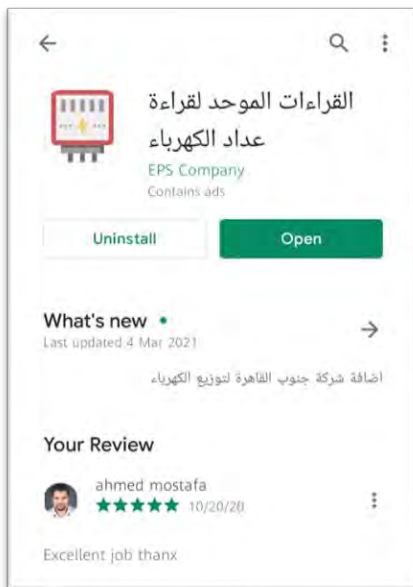

The subscribers' unified readings App record the meter reading and send it instantaneously to its distribution company through the app that photograph the meter and record the reading easily by entering the subscriber's reference and the meter number registered in the electricity bill.

Currently it is available on Google Play and is being added on the Apple App Store

All of this is done through a mobile application installed on mobile phones that run on Android system, which work according to the standards of digital connectivity, to allow the Meter Readers company "Shoaa" to record the Meters readings monthly

The System is currently Implemented Nationwide for the electricity customers at 9 distribution companies and serves over 23 Million Customer

Automation of subscribers' services

The project aims to integrate the daily operations carried out by each of the commercial and technical departments concerned with serving the subscribers

through a computer-based system to automate those processes, as well as issuing monthly invoices in a way that achieves the speed and accuracy of obtaining information and contributing to the decision-making and serving this project includes all subscribers applying to perform services.

ERP Systems

It is an integrated system that includes financial and administrative programs that cannot be dispensed with in all fields because it is compatible with the work system and regulations for each party, whether governmental bodies, private companies or business sectors

It works to serve the individual and the company and provides current and future solutions and speed of implementation so that the information is entered once and traded with all programs to complete the inputs, expenditures, revenues, and archiving of documents.

The activities as follows

1. Preparation of offers and contracting process and project management
2. Requirements Definition
3. Design
4. Development
5. Integration and Testing
6. Installation in customer site

Trouble Call System

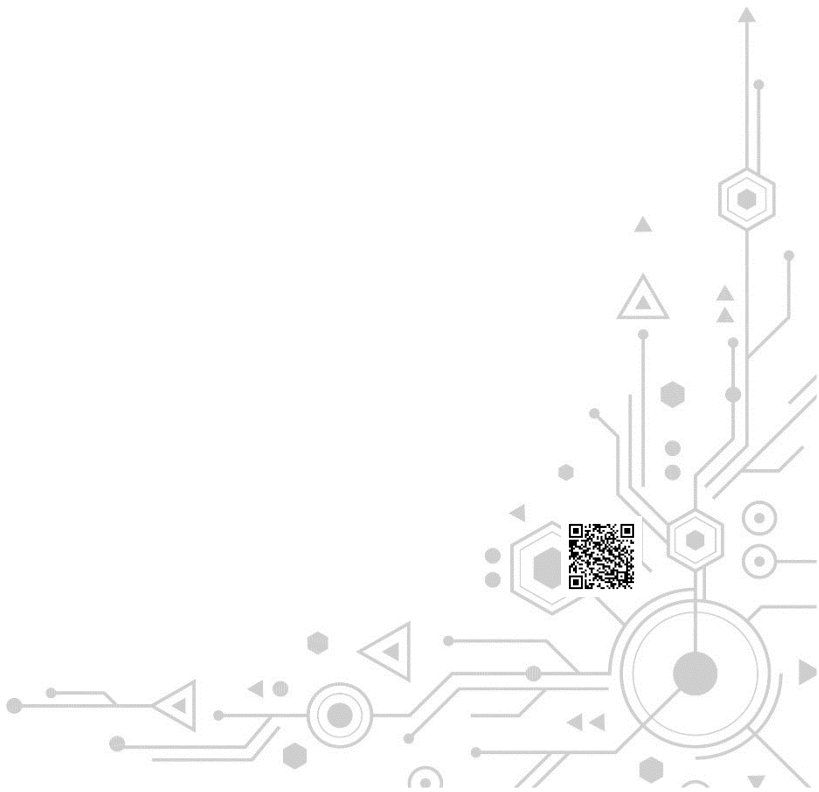
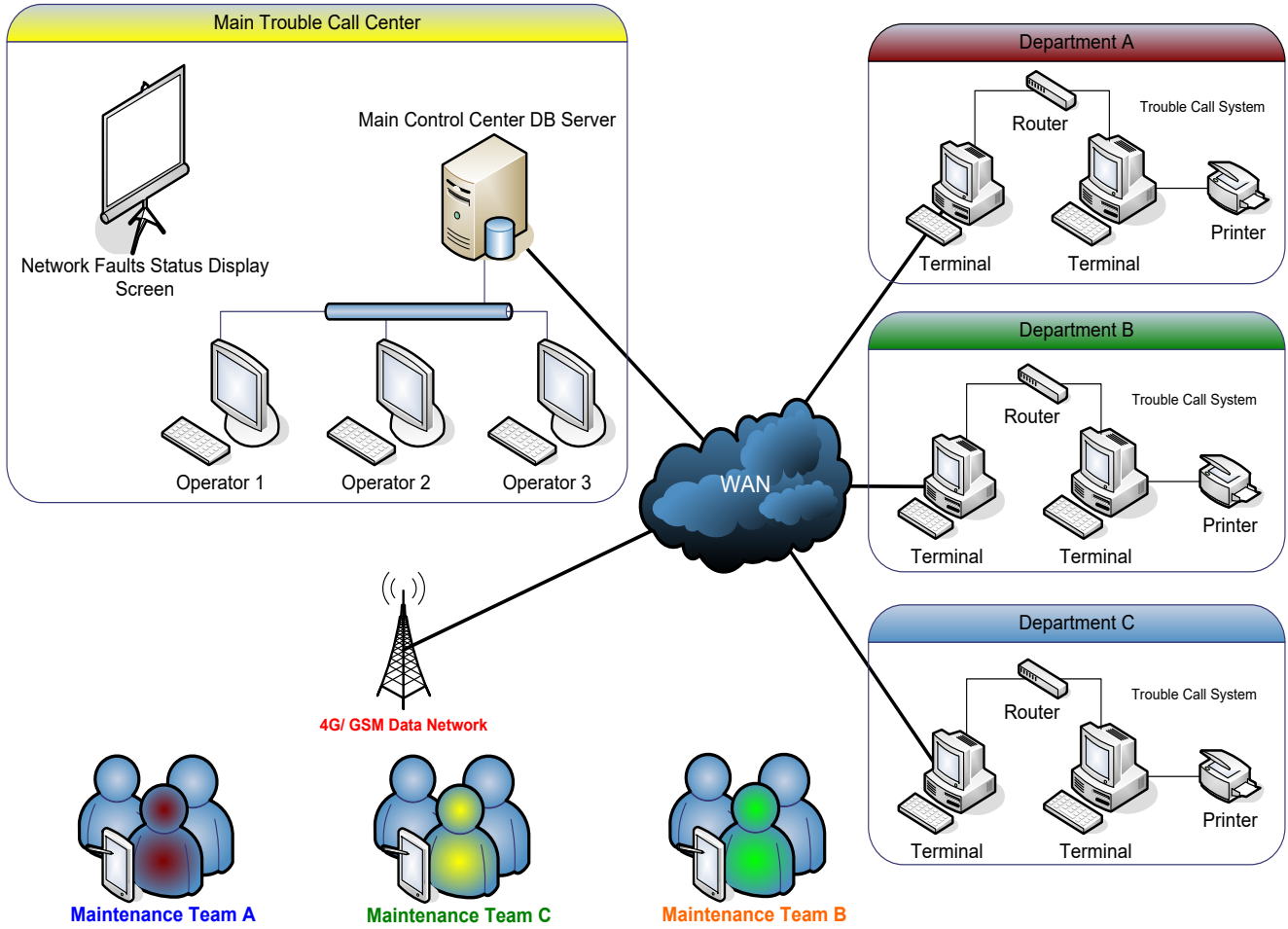

Projects served **626 Projects**

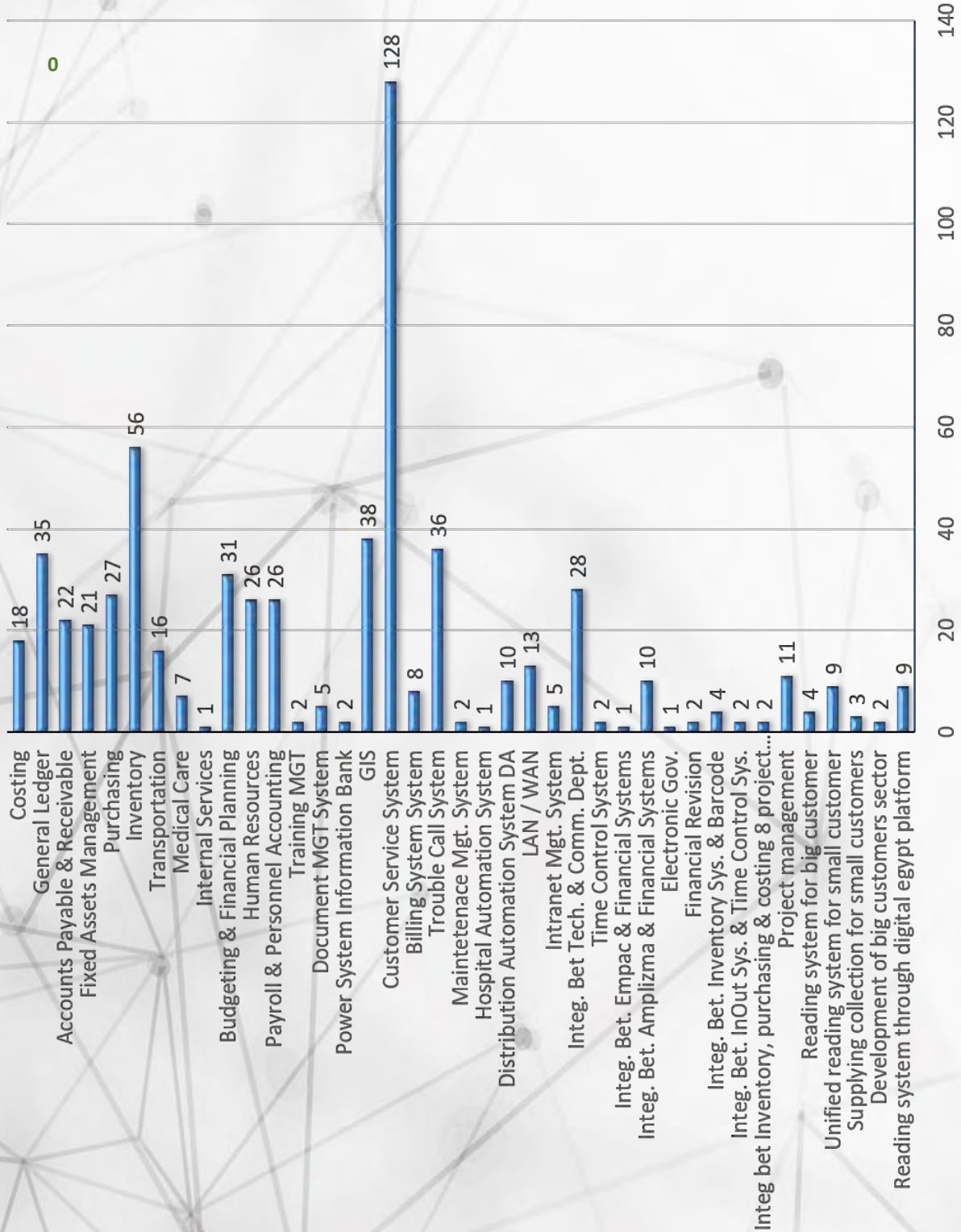

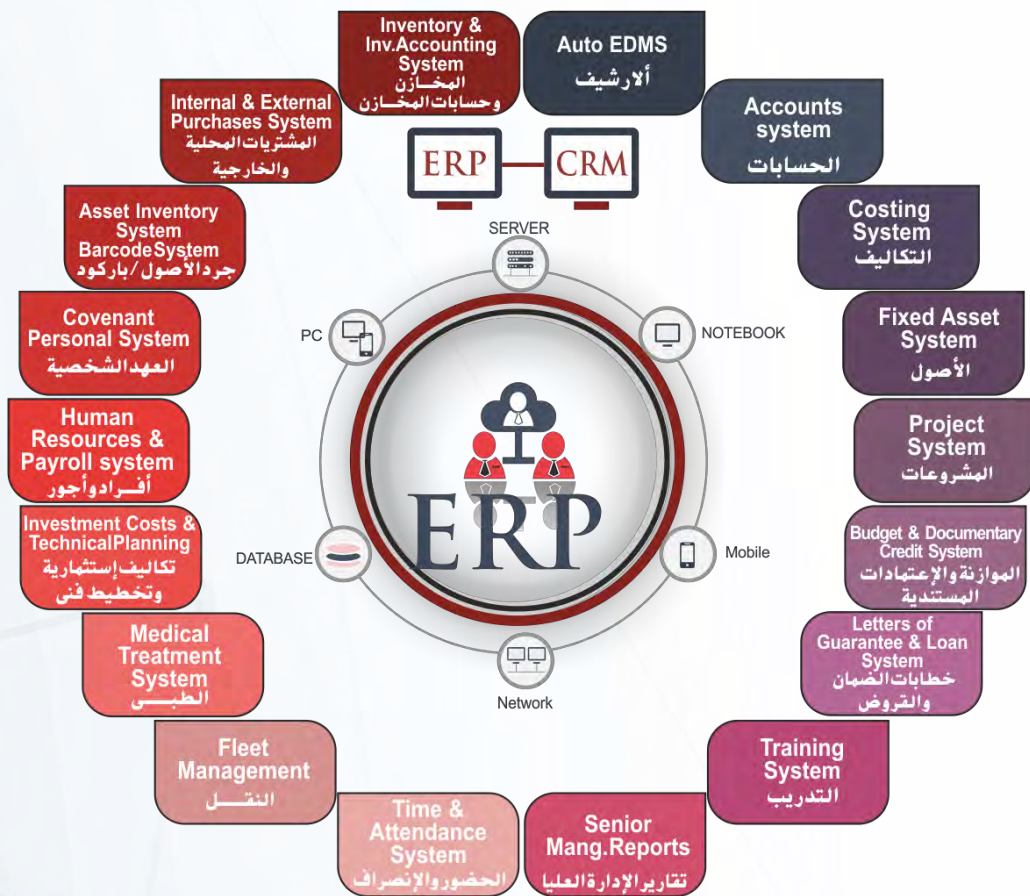
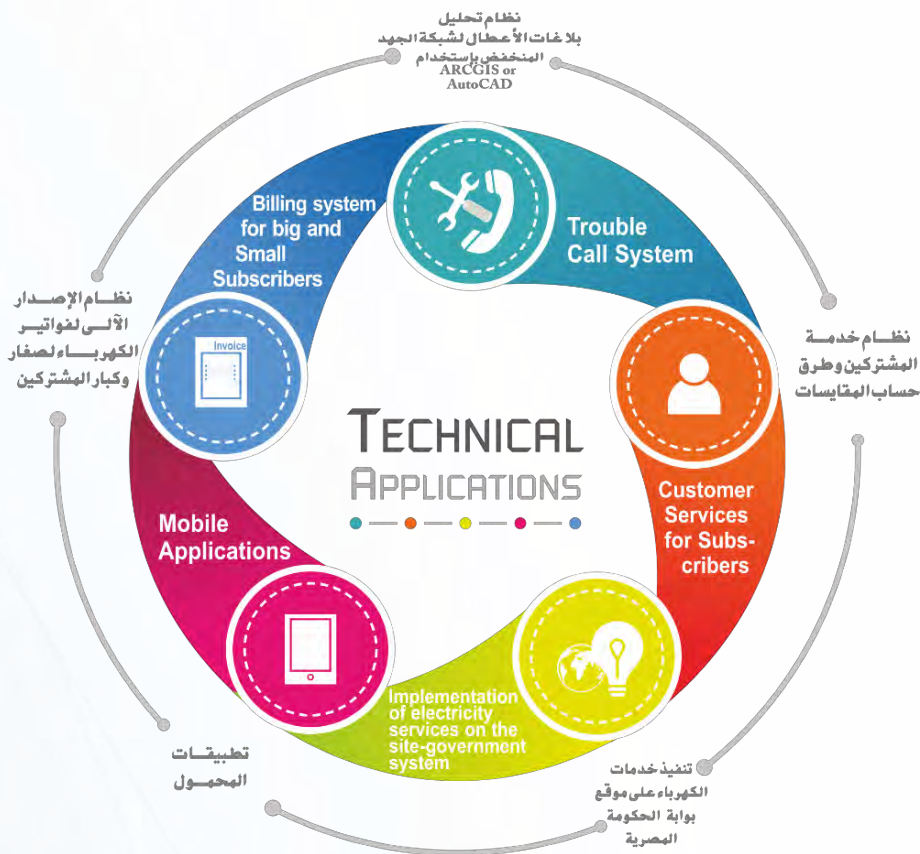

Financial and Administrative Application Systems



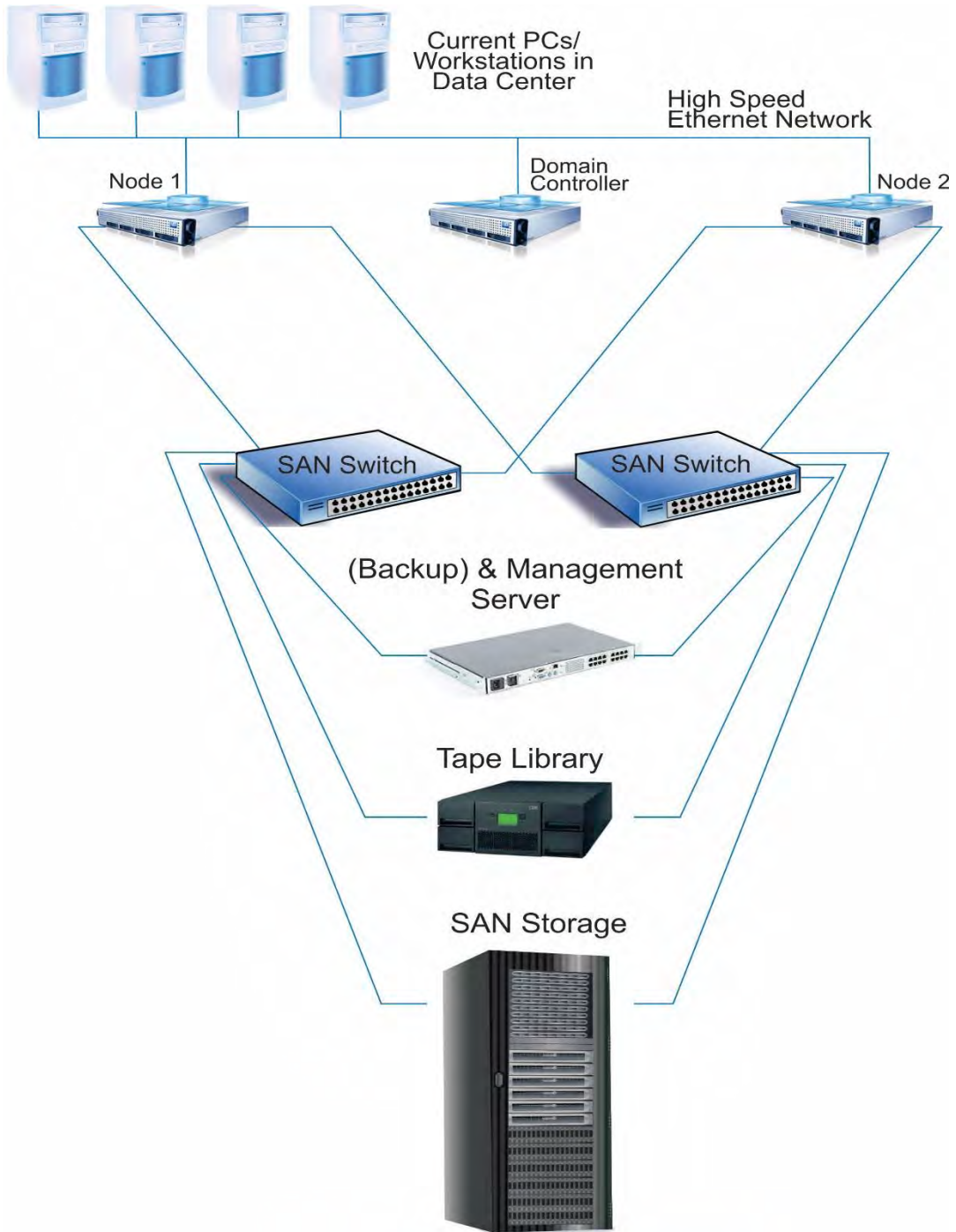

Electricity Billing Systems



EPS TRAINING CENTER



Services

- ⌚ Class-Room Training
- ⌚ On Job Training
- ⌚ Laboratory Testing
- ⌚ Field Training
- ⌚ Software Applications



EPS is providing different training programs. One goal of the training activity is to provide trainees with the specific knowledge and skills necessary to effectively perform their work. The training plan may also include, strategies for marketing. **EPS** training programs covering the fields of Power Stations Projects, Transmission, Distribution, Control Communication, and Information Technology.

Training courses are tailored to meet the needs of individuals, teams and organizations and are customized for developing their skills and improving their innovations and creativity.

EPS has an equipped training facility for formal class-room, and theoretical training. The training programs are structured as a mix of theory, practical experience knowledge, and laboratory experiments.

EPS is using the laboratory facilities available at the Training Centers in Egypt.

The following training programs were provided at **EPS**'s Training Centre:

- High Voltage Substation General Diploma.
- Primary substation Design.
- Substation protection, Testing & commissioning Secondary design.
- Substation protection, Testing & commissioning Secondary design (advanced).
- Power System Studies.
- Project Management.
- Distribution Course Level 1.
- Distribution Course Level 2.
- Substation Automation System (SAS).
- Planning of High Voltage Networks.
- Planning of Distribution Networks.

- Protection Coordination for Electrical Systems.
- Maintenance and Operation of Distribution Networks.
- Improvement of the Performance and efficiency of Power Stations .(Steam, Gas Turbine, Combined, Cycle, Hydraulic, and Diesel Stations).
- Operation and Maintenance of all types of Power Stations.
- Shaft Alignment, Balancing and Vibration monitoring of different types and Power Stations Rotors.
- Operation of Control Centers.
- Geographic Information Systems.
- Modern Transmission Lines Survey using Total Stations.
- Optimum Tower Spotting for High Voltage Transmission Lines using Computers.
- Short Term Unit Commitment for Power Stations.
- Large Scale Project Management.
- Legal Rules and Regulations for Electricity Companies.
- Distribution Networks Design & Planning.
- Safety in substations and switchyards.
- Dielectric oil testing and how to determine the transfer technical state form oil testing results.
- Dielectric gas SF6 testing technical state assignment
- Design and optimization of OHL using PLS-CADD and PLS. Tower SW.
- Electrical network study and planning and network losses reduction.
- Occupation safety and health administration.
- Quality management system documentation control.
- Numerical bay control unit.
- Wireless techniques.
- New generation in telecommunication systems.
- Interfaces between different telecontrol protocols .
- Computerized maintenance.
- Feeder protection, remote terminal units and SCADA systems.
- System grounding design and planning.
- Power feeding for the isolated area far away from the general electrical network.
- Information evaluation.
- Civil survey.
- Using the international standards.
- Power quality improvement for different loads.
- Planning and design methods for distribution for low voltage distribution networks.
- Study of protection against electrical shocks.
- Power Quality and energy saving.

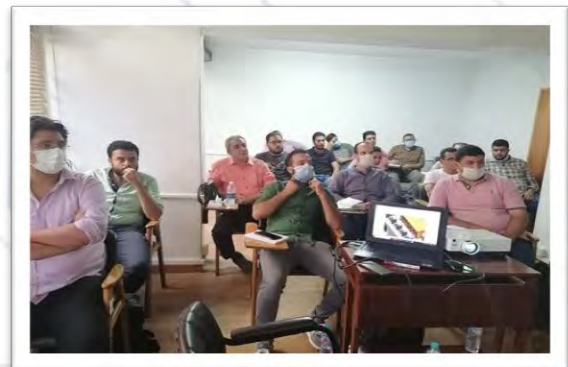

- Electrical network performance implements and new power management .

1- EPS Staff training

The Training for EPS staff includes:

- Governance (Reasonable management)
- Anti-corruption compliance
- Strategi Plans

2- External Trainees

About 150 Trainees from the General Electricity Company of Libya, 50 from Public Electricity Corporation of Yemen, 45 from Southern Sudan Electricity Corporation (SSEC), 10 from Sultanate of Oman and 515 from Egyptian Electricity and Energy Sectors.

In addition to the above programs EPS has conducted training in Software applications to the employees of the different customers. Training covered how to run and maintain the application software in addition to databases such as: ORACLE, SYBASE, ACCESS, etc. Also, operating systems such as: Windows NT, Windows 2000, UNIX and open VMS are covered.

- The Number of Trainees till the end of 2019/20, reached more than **2050** Trainee.

The Training programs are to be organized at different locations as follows:

- EPS's Training Center at Cairo.
- Hotels.
- Customer's premises.
- Ministry of Electricity & Renewable (MERE) and EDCS's laboratories training Centers and site visits to the power utilities.



EPS

WWW.EPS-EGYPT.COM



Address : Misr Lel Taameir - Sheraton Heliopolis - 8th Zone, 9 St., Building No. 7 - Cairo - Egypt
P.O. Box : 90 Rawdat El Sheraton
Tel. : (202) 22669414/424/427/437 - (202) 22661852
Fax : (202) 22661810
Mobile : (20) 1229126333/222 Whatapp : (20) 01211114498
Web Site : www.eps-egypt.com - E-mail : eps@eps-egypt.com
Near by : Cairo Airport, Radisson Hotel

Designed By Sherine Shehata